

A (Axilla to Floor Height)
 W (Wrist to Floor Height)
 G (Groin to Floor Height)
 H (Hip Width)

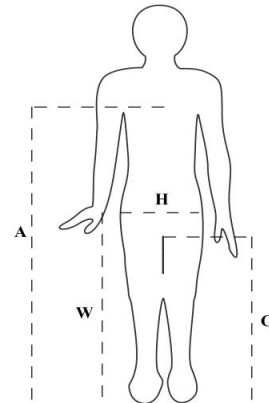

Features included in standard price:

- Angle Adjustable Frame
- Quick Release Wheels
- Central Braking System
- Four Casters
- Spoke Protectors

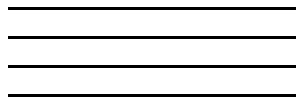

Measurements

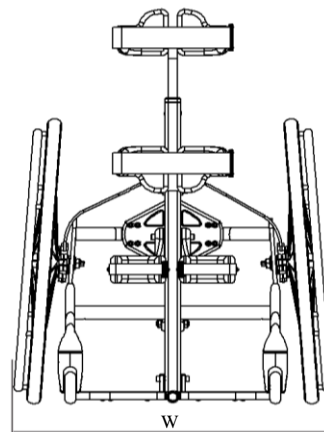
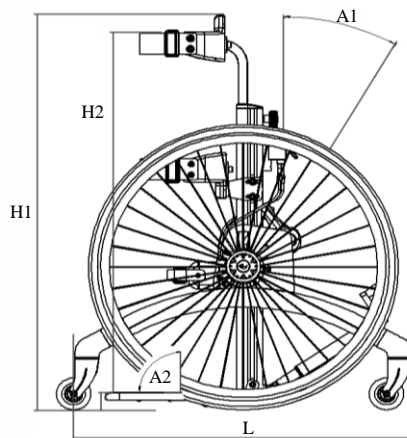

	Size 1 w/22" wheels cm (inch)	Size 2 w/26" wheels cm (inch)	Size 3 w/32" wheels cm (inch)	Size 4 w/36" wheels cm (inch)
Length (L)	24¼"	29¼"	29¼"	33¼"
Total length	24¼"	29¼"	31¼"	35"
Width (W)	22½"	26½"	27"	27¼"
Height from floor. Maximum Height (H1)	39"	46"	51"	59¾"
Height from floor. Minimum Height (H1)	26¼"	33¼"	38½"	46¾"
Height from foot plate. Maximum Height (H2)	29"	42"	46½"	54¼"
Height from foot plate. Minimum Height (H2)	22¼"	29¼"	33½"	41¼"
Angle of the center bar (A1)	0 to +30°	0 to +30°	0 to +30°	0 to +30°
Angle of the foot plate (A2)	+15° to -10°	+15° to -10°	+15° to -10°	+15° to -10°
Camber	4°	4°	4°	4°
Maximum user weight	89 lb	111 lb	133 lb	155 lb
Unit Weight	29½ lb	34 lb	35 lb	40½ lb

Account No. _____ Drop Ship: _____
 Date: _____ Name _____
 P.O. Number: _____ Address _____
 Buyer: _____ City _____
 Marked For: _____ State _____ Zip _____
 E Mail: _____ Tel. _____ Fax _____

Phone: 1-800-336-7684 Fax: 704-882-0751 www.snugseat.com PO Box 1739 Matthews, NC 28106





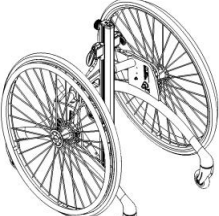

Rabbit	Description	Size	Part No.	Price - CAD
FRAME				
	Rabbit, red	1	X8621	2,195 <input type="checkbox"/>
	Rabbit, blue	2	X8622	2,195 <input type="checkbox"/>
	Rabbit, blue	3	X8623	2,895 <input type="checkbox"/>
	Rabbit, silver	4	X8624	2,895 <input type="checkbox"/>







REAR DRIVING WHEELS*



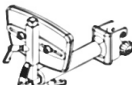
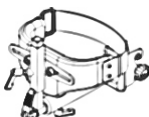
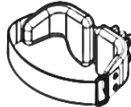
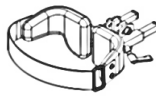

22"		22"	X862722	825 <input type="checkbox"/>
24"		24"	X862724	825 <input type="checkbox"/>
26"		26"	X862726	825 <input type="checkbox"/>
29"		29"	X862729	1,195 <input type="checkbox"/>
32"		32"	X862732	1,195 <input type="checkbox"/>
36"		36"	X862736	1,195 <input type="checkbox"/>

*Large driving wheel include spoke protectors and are required with the purchase of a frame. Wheels purchased separately are priced differently.

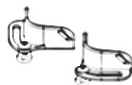
Accessories

	Chest support, size 1 bar, size 2/3 chest pad	1	861704	275 <input type="checkbox"/>
	Chest support, Height & Width Adjustable	2+3	861702	275 <input type="checkbox"/>
	Chest support, Height & Width Adjustable	4	861703	310 <input type="checkbox"/>
	Extension for center bar, 3" Allows the chest support to be mounted in a higher position	one size	861480	110 <input type="checkbox"/>
	Tray with storage box <i>Can only be used with chest support</i>	one size	862501	495 <input type="checkbox"/>
	Simple Tray	one size	862515	475 <input type="checkbox"/>
	Abdominal support	one size	861411	200 <input type="checkbox"/>
	Filler Pad, small - adds 1" expansion to chest or hip pads		861421	80 <input type="checkbox"/>
	Filler Pad, large - adds 2" expansion to chest or hip pads		861422	80 <input type="checkbox"/>

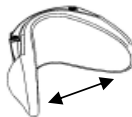
	Description	Size	Part No.	Price - CAD	
	Pommel and sacral support	one size	861401	585	<input type="checkbox"/>
	Hip support w/pommel, Hgt Adjustable	1	861501	695	<input type="checkbox"/>
	Hip support w/pommel, Hgt & Width Adjus	2+3	861502	695	<input type="checkbox"/>
	Hip support w/pommel, Hgt & Width Adjus	4	861503	695	<input type="checkbox"/>
All hip supports include a strap					
	Hip support, Front mount, Hgt Adjustable	1	861601	310	<input type="checkbox"/>
	Hip support, Front mount, Hgt & Width Ac	2+3	861602	310	<input type="checkbox"/>
	Hip support, Front mount, Hgt & Width Ac	4	861603	330	<input type="checkbox"/>
	Hip support, rotational, Height Adjustable	1	861611	465	<input type="checkbox"/>
	Hip support, rotational, Hgt & Width Adj	2+3	861612	465	<input type="checkbox"/>
	Hip support, rotational, Hgt & Width Adj	4	861613	495	<input type="checkbox"/>
	Knee supports, including straps, set	1	861301	355	<input type="checkbox"/>
	Knee supports, including straps, set	2+3	861302	465	<input type="checkbox"/>
	Knee supports, including straps, set	4	861303	465	<input type="checkbox"/>
	Hinged knee supports, incl. strap	1	861311	565	<input type="checkbox"/>
	Hinged knee supports, incl. strap	2+3	861312	565	<input type="checkbox"/>
	Hinged knee supports, incl. strap	4	861313	565	<input type="checkbox"/>
	Flip up foot plate	1	861211	275	<input type="checkbox"/>
	Flip up foot plate	2+3+4	861212	275	<input type="checkbox"/>
<u>FOOTPLATE ACCESSORIES - Require Flip up footplate</u>					
	Footstraps, plastic lock	one size	36-8596	65	<input type="checkbox"/>
	Shoe holders for flip up footplate	8¼" x 3¾"	86147	195	<input type="checkbox"/>
	Shoe holders for flip up footplate	9¼" x 4½"	86148	195	<input type="checkbox"/>
	Hinged sandals	1	861221	180	<input type="checkbox"/>
	Hinged sandals	2+3	861222	180	<input type="checkbox"/>
	Hinged sandals	4	861223	180	<input type="checkbox"/>
<i>For flip-up foot plate, includes straps</i>					
	Separate foot rests with hinged sandal	1	861201	495	<input type="checkbox"/>
	Separate foot rests with hinged sandal	2+3	861202	495	<input type="checkbox"/>
<i>Includes straps</i>					
	Heel stop	one size	861251	75	<input type="checkbox"/>

	Description	Size	Part No.	Price - CAD
Headrests				
You must select a Swing-away Mounting Bracket and Headrest Style				
	Swing-away Bracket - Height, Depth, Angle & Lateral Adjustable			
	Mounting for Head support	1 & 2	861424-1	440 <input type="checkbox"/>
	Mounting for Head support	3, 4, & 5	861424-2	440 <input type="checkbox"/>
	Head support no. 1		6171550	290 <input type="checkbox"/>
	Head support no. 2		6172550	290 <input type="checkbox"/>
	Head support no. 3		6173550	290 <input type="checkbox"/>
	Head support no. 4		6174550	290 <input type="checkbox"/>
	Anatomic head support*, Small - A = 3", B = 8"		5099001	250 <input type="checkbox"/>
	Anatomic head support*, Medium - A = 3", B = 10¼"		5099002	250 <input type="checkbox"/>
	Anatomic head support*, Large - A = 4¼", B = 13"		5099003	250 <input type="checkbox"/>
<i>*Includes black DUCUTEX cover</i>				
	Headband System (For Anatomic Head Support only)		99500	250 <input type="checkbox"/>
	Extra headband strap (For Anatomic Head Support only)		99400-5	55 <input type="checkbox"/>
All of the above Head Supports are Black Polyurethane				
	Adjustable Width Headrest, large laterals, no speakers**		99737XX-85	300 <input type="checkbox"/>
	Speakers for Adjustable Width Headrest, large laterals		X99717XX-85	95 <input type="checkbox"/>
	<i>**Includes black Mesh cover</i>			
Spare parts				
	Strap for hip support	1	861621	67 <input type="checkbox"/>
	Strap for hip support	2+3	861622	67 <input type="checkbox"/>
	Strap for hip support	4	861623	67 <input type="checkbox"/>
	Straps for knee support, set	1	861341	62 <input type="checkbox"/>
	Straps for knee support, set	2+3+4	861342	62 <input type="checkbox"/>
	Straps for Flip up foot plate sandals, set	1	861241	103 <input type="checkbox"/>
	Straps for Flip up foot plate sandals, set	2+3+4	861242	103 <input type="checkbox"/>
	Spoke protector, each	22"	862622	165 <input type="checkbox"/>
	Spoke protector, each	24"	862624	165 <input type="checkbox"/>
	Spoke protector, each	26"	862626	165 <input type="checkbox"/>
	Spoke protector, each	29"	862629	235 <input type="checkbox"/>
	Spoke protector, each	32"	862632	235 <input type="checkbox"/>
	Spoke protector, each	36"	862636	235 <input type="checkbox"/>

NOTES