

O (Overall Height) \_\_\_\_\_  
 C (Chest Width) \_\_\_\_\_  
 S (Shoulder Width) \_\_\_\_\_  
 H (Hip Width) \_\_\_\_\_  
 G (Groin to Floor) \_\_\_\_\_

Features included in standard price



Size 1, 2, 3, and 4  
 Frame color: 1 = yellow, 2 = red, 3 = blue, 4 = gray  
 Base with 4" locking casters  
 Height and angle adjustable two-piece footrest  
 Tilt from vertical to past horizontal  
 Contoured top pad

Measurements

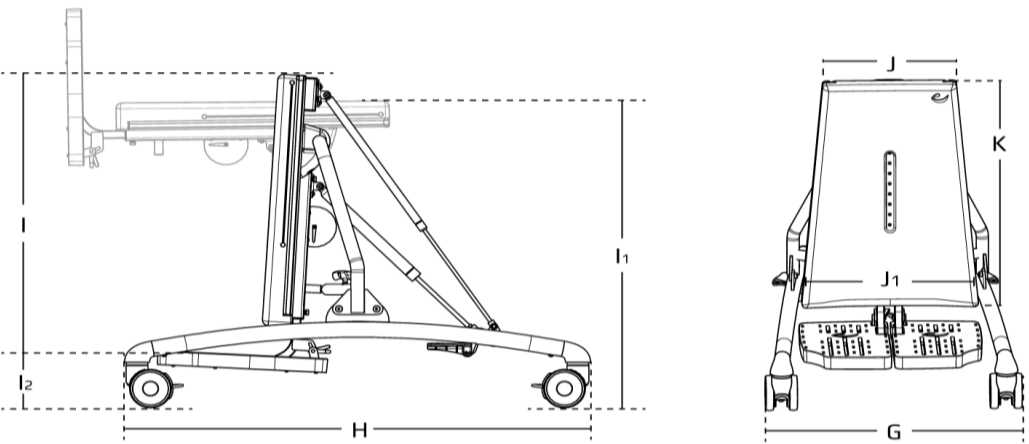









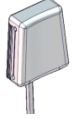

	Size 1 inch	Size 2 inch	Size 3 inch	Size 4 inch
Frame width (G)	20	22½	25½	29¼
Frame length (H)	29¼	36	43¼	43¼
Height, vertical (I1)	18-22½	20¾-25¼	26¾-31	34¾-39
Height, horizontal (I1)	27½	27½	31½	31½
Height from floor to frame (I2)	5	5	5	5
Base pad width, top-bottom (J-J1)	9¾-12½	11¾-15	13¾-18	15¾-21¾
Base pad height (K)	17	19¾	25½	33½
Angling	3° to 90°	3° to 90°	3° to 90°	3° to 90°
Foot plate angling	-10° to 10°	-10° to 10°	-10° to 10°	-10° to 10°
Weight, wo/power	45.2 lb	53 lb	67.2 lb	77.2 lb
Weight, w/power	49.6 lb	56.2 lb	71.7 lb	81.6 lb
Max load	88.2 lb	132.3 lb	176.4 lb	220.5 lb
Supine - User Shoulder Height*	26"-36¾"	30¾"-43"	39½"-51½"	50½"-62½"
Prone - User Armpit Height	18"-36½"	21"-43"	27"-51½"	34½"-62½"

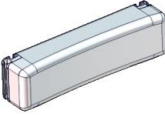

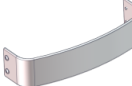

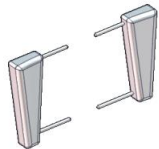
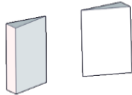
\*Headrest can be added for additional height

Account No. \_\_\_\_\_ Drop Ship: \_\_\_\_\_  
 Date: \_\_\_\_\_ Name \_\_\_\_\_  
 P.O. Number: \_\_\_\_\_ Address \_\_\_\_\_  
 Buyer: \_\_\_\_\_ City \_\_\_\_\_  
 Marked For: \_\_\_\_\_ State \_\_\_\_\_ Zip \_\_\_\_\_  
 E Mail: \_\_\_\_\_ Tel. \_\_\_\_\_ Fax \_\_\_\_\_

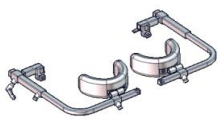
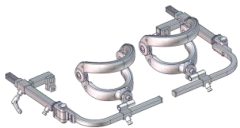
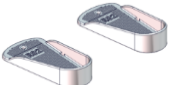
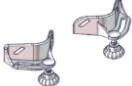
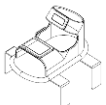
Phone: 1-800-336-7684 Fax: 704-882-0751 www.snugseat.com PO Box 1739 Matthews, NC 28106





	Description	Size	Part No.	Price - CDN	
	Caribou base with parted foot plates	size 1	860101-FP	3,500	<input type="checkbox"/>
	Caribou base with parted foot plates	size 2	860102-FP	3,595	<input type="checkbox"/>
	Caribou base with parted foot plates	size 3	860103-FP	3,895	<input type="checkbox"/>
	Caribou base with parted foot plates	size 4	860104-FP	4,250	<input type="checkbox"/>
	Caribou base with power actuator	size 1	860101-EL	5,800	<input type="checkbox"/>
	Caribou base with power actuator	size 2	860102-EL	5,900	<input type="checkbox"/>
	Caribou base with power actuator	size 3	860103-EL	6,300	<input type="checkbox"/>
	Caribou base with power actuator	size 4	860104-EL	6,700	<input type="checkbox"/>
	Top pad, w 1:6", w 2:7", H: 8"	size 1	861101-1	N/C	<input type="checkbox"/>
	Top pad, w 1: 7½", w 2: 9", H: 9¾"	size 2	861101-2	N/C	<input type="checkbox"/>
	Top pad, w 1: 8½", w 2: 10½", H: 12½"	size 3	861101-3	N/C	<input type="checkbox"/>
	Top pad, w 1: 9¾", w 2: 12¼", H: 15¾"	size 4	861101-4	N/C	<input type="checkbox"/>
<b>Important: Please select a top pad for the Caribou base</b>					
				Quantity	
	Head pad - 7½" height, 6" width	for sizes 1+2	861116-1	495	<input type="checkbox"/>
	Head pad - 9½" height, 8" width	for sizes 3+4	861116-2	495	<input type="checkbox"/>
	Chest strap length: 16½" - 25"	for sizes 1+2	862101-2	150	<input type="checkbox"/>
	Chest strap length: 19" - 30½"	for size 3	862101-3	150	<input type="checkbox"/>
	Chest strap length: 15¾" - 38"	for size 4	862101-4	150	<input type="checkbox"/>
<b>Note: A chest strap is not included as standard</b>					
	Cross straps length: 16½" - 19¼"	size 1	862102-1	375	<input type="checkbox"/>
	Cross straps length: 17" - 21¾"	size 2	862102-2	375	<input type="checkbox"/>
	Cross straps length: 21" - 27½"	size 3	862102-3	395	<input type="checkbox"/>
	Cross straps length: 24¾" - 33¾"	size 4	862102-4	395	<input type="checkbox"/>
	Extra cushion, W: 9¾" H: 3¼"	for all sizes	861106-1	295	<input type="checkbox"/>
	Extra cushion, W: 12" H: 4"	for all sizes	861106-2	295	<input type="checkbox"/>
	Extra cushion, W: 13¾" H: 4"	for all sizes	861106-3	320	<input type="checkbox"/>
	Extra cushion, W: 15¾" H: 4"	for all sizes	861106-4	320	<input type="checkbox"/>
	Side supports, set, size 1	for all sizes	861102-1	375	<input type="checkbox"/>
	Side supports, set, size 2	for all sizes	861102-2	375	<input type="checkbox"/>
	Side supports, set, size 3	for all sizes	861102-3	375	<input type="checkbox"/>
<b>Width between laterals on torso pad (min-max)</b>					
	Size 1 - 4" to 9"	Size 2 - 6½" to 14"	Size 3 - 12" to 18"	Quantity	
	Lateral support strap length, 10" - 12½"	size 1	862103-1	65	<input type="checkbox"/>
	Lateral support strap length, 12" - 16"	size 2	862103-2	65	<input type="checkbox"/>
	Lateral support strap length, 13½" - 19¾"	size 3	862103-3	65	<input type="checkbox"/>

	Description	Size	Part No.	Price - CDN
	Shoulder support, set, w: 3" h: 7½" d: 2"	for size 1	861126-1	350 <input type="checkbox"/>
	Shoulder support, set, w: 3¼" h: 9½" d: 2"	for size 2	861126-2	350 <input type="checkbox"/>
	Shoulder support, set, w: 4" h: 12¼" d: 2"	for size 3	861126-3	350 <input type="checkbox"/>
	Shoulder support, set, w: 4¼" h: 15½" d: 2"	for size 4	861126-4	350 <input type="checkbox"/>
	Wedges for side slots	size 1	861107-1	22 <input type="checkbox"/>
	Wedges for side slots	size 2	861107-2	22 <input type="checkbox"/>
	Wedges for side slots	size 3	861107-3	22 <input type="checkbox"/>
	Back support	for sizes 1+2	861115-1	300 <input type="checkbox"/>
	Back support	for sizes 3+4	861115-4	425 <input type="checkbox"/>
	Pommel, w: 2", w: 2¾, h: 6", d: 6¾"	for all sizes	861103-1	170 <input type="checkbox"/>
	Pommel, w: 2", w: 2¾, h: 6", d: 3½"	for all sizes	861103-2	180 <input type="checkbox"/>
	Pommel strap, length: 10" - 12"	for all sizes	862104-1	210 <input type="checkbox"/>
	Pommel strap, length: 10½" - 18½"	for all sizes	862104-2	210 <input type="checkbox"/>
	Knee support, fixed, size 1	for sizes 1+2	861144-2	475 <input type="checkbox"/>
	Knee support, swing away, size 1	for sizes 1+2	861154-2	875 <input type="checkbox"/>
	Knee support, fixed, size 2	for sizes 3+4	861144-3	475 <input type="checkbox"/>
	Knee support, swing away, size 2	for sizes 3+4	861154-3	875 <input type="checkbox"/>
	Knee support, hinged, fixed, size 1	for sizes 1+2	861144-20	695 <input type="checkbox"/>
	Knee support, hinged, swing away, size 1	for sizes 1+2	861154-20	995 <input type="checkbox"/>
	Knee support, hinged, fixed, size 2	for sizes 3+4	861144-30	695 <input type="checkbox"/>
	Knee support, hinged, swing away, size 2	for sizes 3+4	861154-30	995 <input type="checkbox"/>
	Formed foot plates, set, 8½"L, 3"W at heel, 4"W at toe		86147	195 <input type="checkbox"/>
	Formed foot plates, set, 9½"L, 3½"W at heel, 4½"W at toe		86148	195 <input type="checkbox"/>
	Foot straps with plastic locks	all sizes	36-8596	65 <input type="checkbox"/>
	Foot straps with Velcro	all sizes	36-8502	65 <input type="checkbox"/>
	Foot straps with Velcro extra long (22")	all sizes	36-8502-XL	70 <input type="checkbox"/>
	Heel support for parted foot support, set	for size 1+2	861251	75 <input type="checkbox"/>
	Heel support for parted foot support, set	for size 3+4	861252	75 <input type="checkbox"/>
	Neoprene sandals, set	all sizes	85696-1	175 <input type="checkbox"/>

	Description	Size	Part No.	Price - CDN
	Tray, plastic, with bowl and cover	size 1+2	862130-2	700 <input type="checkbox"/>
	Tray, plastic, with bowl and cover	size 3+4	862130-3	700 <input type="checkbox"/>
	Tray, plastic, w/ bowl and cover, low mount	size 1	862131-1	700 <input type="checkbox"/>
	Tray, plastic, w/ bowl and cover, low mount	size 2+3	862131-2	700 <input type="checkbox"/>
	Kit for low mount of tray	Size 1+2+3	862131-KIT	305 <input type="checkbox"/>
	Arm rests for plastic tray	all sizes	861131	195 <input type="checkbox"/>
	Toybar for plastic tray	all sizes	861135	295 <input type="checkbox"/>
	Grip handle for plastic tray	all sizes	861136	450 <input type="checkbox"/>
	Push handle	all sizes	900545	135 <input type="checkbox"/>
	Power Kit, complete	sizes 1 & 2	861140	2,275 <input type="checkbox"/>
	Power Kit, complete	size 3	861150	2,275 <input type="checkbox"/>
	Power Kit, complete	size 4	861160	2,275 <input type="checkbox"/>

**Other Head supports - See Headrest price list for measurements**

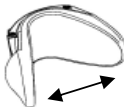
The headrest pads require the Turtle Bar System below!

<b>HCPCS - E0955</b>				
<b>Headrest Style</b>				
	Head support no. 1		6171550	290 <input type="checkbox"/>
	Head support no. 2		6172550	290 <input type="checkbox"/>
	Head support no. 3		6173550	290 <input type="checkbox"/>
	Head support no. 4		6174550	290 <input type="checkbox"/>
	Without cover		0	NC <input type="checkbox"/>
	Blue Comfort		15	85 <input type="checkbox"/>
	Black Decutex		83	85 <input type="checkbox"/>
	Anatomic head support, Small (Black Decutex Cover)		5099001	325 <input type="checkbox"/>
	Anatomic head support, Medium (Black Decutex Cover)		5099002	325 <input type="checkbox"/>
	Anatomic head support, Large (Black Decutex Cover)		5099003	325 <input type="checkbox"/>
	Headband System (For Anatomic Head Support only)		99500	295 <input type="checkbox"/>
	Extra headband strap (For Anatomic Head Support only)		99400-5	75 <input type="checkbox"/>
	Adjustable Width Headrest, large laterals, without speakers**		99737XX-85	325 <input type="checkbox"/>
	Speakers for Adjustable Width Headrest, large laterals		X99717XX-85	125 <input type="checkbox"/>
<b>**Includes black Mesh cover</b>				
<b>HCPCS - E1028</b>				
	Swing-away Bracket - Height, Depth, Angle & Lateral Adjustable			
	Turtle bar system, long		98619-26	295.00 <input type="checkbox"/>