

Topaz 8 Plus

Alternating Pressure and Micro Low Air Loss Pressure Relief System

User Manual



Manufactured by: Air Kinetic Technologies Corp.
Distributed by: Quart Healthcare Inc. & Quart Healthcare West Inc.

www.quarthealthcare.com

IMPORTANT SAFEGUARDS

READ ALL INSTRUCTIONS BEFORE OPERATING THIS DEVICE



NOTE - CAUTION AND WARNING STATEMENTS:

NOTE – Indicates a tip.

CAUTION – Indicates correct operating or maintenance procedures in order to prevent damage to, or destruction of, the equipment or other property.

WARNING – Indicates a potential danger that requires correct procedures or practices in order to prevent personal injury.



WARNING – To reduce the risk of electrocution:

1. Always unplug this product immediately when not in use.
2. Do not disassemble the Control Unit.
3. Do not place or store product where it can fall or be pulled into a tub or sink.
4. Do not place in or drop into water or other liquid. Do not use while bathing.
5. Do not reach for a product that has fallen into water. Unplug immediately.













WARNING – To reduce the risk of burns, electrocution, fire or injury to persons:

1. The operation of this system requires that the mattress is connected to the Control Unit. Please do not power-off or unplug the Control Unit while in operation.
2. Always use the same voltage as stated on the label. Do not use other power cords on the Control Unit.
3. Equipment is not suitable to use in the presence of a flammable anesthetic mixture with air or with oxygen or nitrous oxide.
4. Keep away from sharp objects.
5. Close supervision is necessary when this product is used by, on, or near pets and / or children.
6. Use this product only for its intended use as described in this manual. Do not use attachments that are not recommended by the manufacturer.
7. Never operate this product if the Control Unit has a damaged power cord or plug, if the Control Unit is not working properly, if the Control Unit has been dropped or damaged, or the Control Unit has come in contact with water. Return the product to a service center or to the distributor for assessment and repair.
8. Keep the power cord away from heated surfaces.
9. Never block the air openings of this product or place the product on a soft surface, such as a bed or couch, where the openings may be blocked. Keep the air opening free of lint, hair, and other similar particles.

10. Never drop or insert any object into any air opening or hose tube.
11. Avoid dropping or putting any heavy object on the Control Unit.
12. Place the power cord and hose tube at the foot of the bed to avoid tripping or other hazards with cord.
13. Remove all electro-magnetic or RF generated equipment from close proximity, to avoid electromagnetic interference.
14. The Control Unit will have minor heat generated in operation, avoid prolonged contact.
15. When the main power supply is lost or has failed temporarily, the Control Unit will stop working and the power failure alarm will sound for up to 20 minutes. This is normal and the product will return to normal operation once power is resumed.

Product Symbol Description

SYMBOLS	DESCRIPTION
I	POWER ON
O	POWER OFF
	ATTENTION
	DOUBLE INSULATION
	“BF” SYMBOL, INDICATES THIS PRODUCT IS IN ACCORDANCE TO THE DEGREE OF PROTECTION AGAINST ELECTRIC SHOCK FOR TYPE BF EQUIPMENT, APPLIED PART: MATTRESS
	CAUTION, READ THE INSTRUCTION MANUAL BEFORE USE
	KEEP AWAY FROM FLAMMABLE MATERIALS
IP21	WATER AND DUST PROTECTION CLASSIFICATION
	FUZE SPECIFICATION
	DISPOSAL OF ELECTRICAL & ELECTRONIC EQUIPMENT (WEEE): THIS PRODUCT SHOULD BE HANDED OVER TO AN APPLICABLE COLLECTION POINT FOR THE RECYCLING OF ELECTRICAL AND ELECTRONIC EQUIPMENT.
	UL CERTIFICATION LOGO (COMPLIACE WITH IEC60601-1) WITH RESPECT TO ELECTRICAL SHOCK, FIRE AND MECHANICAL HAZARDS ONLY IN ACCORDANCE WITH IEC60601-1.
	CB CERTIFICATION LOGO
	CE CERTIFICATION LOGO

Contents

1.	INTRODUCTION	5
2.	INTENDED USE	5
3.	PRODUCT DESCRIPTION	5
4.	PRODUCT INSTALLATION GUIDE	6
5.	PANEL DISPLAY AND OPERATION GUIDE	8
6.	CLEANING	13
7.	STORAGE	14
8.	MAINTENANCE	14
9.	DISPOSAL OF AIR MATTRESS	15
10.	TROUBLESHOOTING	15
11.	TECHNICAL DATA	16

1. INTRODUCTION

This manual provides the information required for the initial set up and normal operation of the **Quart Healthcare Topaz 8 Plus Alternating Pressure Low Air Loss Mattress System**. Before operating this Mattress System, be sure the operator has read and understood in detail the content of this manual.

2. INTENDED USE

- The **Topaz 8 Plus Alternating Pressure Low Air Loss Mattress System** is intended to reduce the incidences of pressure wounds while optimizing an individual's comfort.
- The **Topaz 8 Plus Alternating Pressure Low Air Loss Mattress System** may be used in a variety of settings including, but not limited to an individual in a home care setting or a long-term care setting who is suffering from skin breakdown, or pain management as prescribed by physician.



NOTE: Equipment is not suitable for use in the presence of a flammable anesthetic mixture with air or with oxygen or nitrous oxide.

3. PRODUCT DESCRIPTION

The **Topaz 8 Plus Alternating Pressure Low Air Loss Mattress System** is an alternating pressure mattress replacement system used in the prevention and relief for patients with, or vulnerable to, pressure wounds. The mattress offers patients a comfortable and relaxing support surface by using the established principles of alternating therapy, which can both prevent skin breakdown and enhance healing.

The Control Unit of the **Topaz 8 Plus Alternating Pressure Low Air Loss Mattress System** features a digital pressure adjustment function, mode selections, and audiovisual alarms. The 18 air cells in the mattress provide a unique design which keeps the lower sections of air cells constantly inflated while alternating and deflating the upper sections. The 3 head cells remain static and provide a "pillow" support for optimum comfort. The mattress has a heavy-duty polyester base sheet with a vapor permeable two way stretch with PU coated cover.

The system includes a rapid release twist CPR valve by the head section of the mattress for the event of cardiac arrest.

4. PRODUCT INSTALLATION GUIDE

1. Unpack the box to inspect all items for any damage that may have occurred during shipping. If there is any damage, please contact your dealer immediately for assistance.
2. Place the mattress on top of the bed frame. The feet symbol on both sides of the mattress indicates location of the foot end.

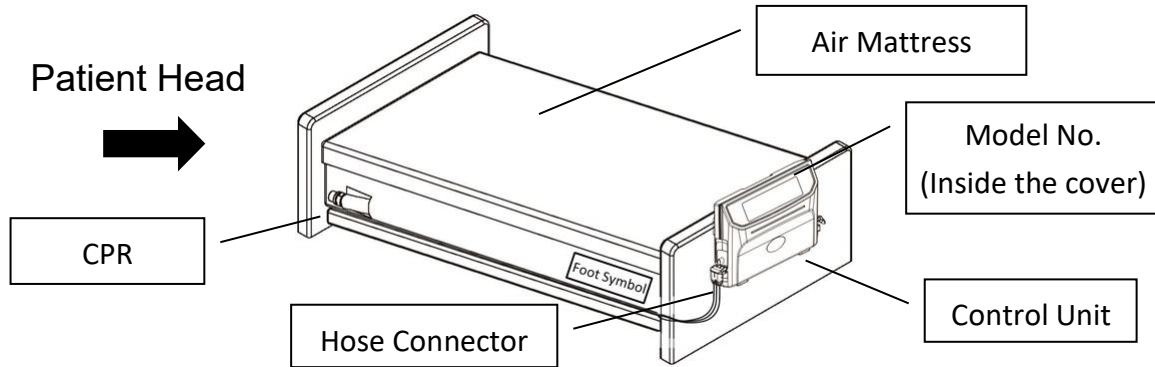

3. Secure the mattress onto the bed frame by using the elastic straps or binding side straps.

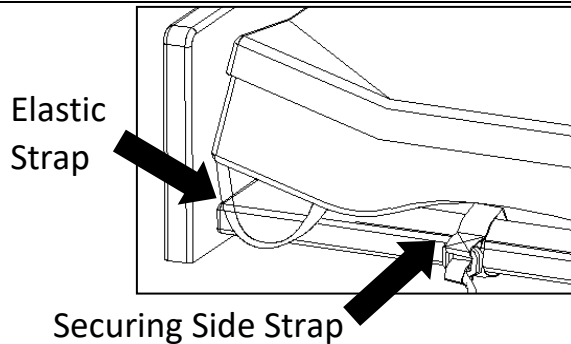

4. Ensure the CPR valve is at CLOSE position before turning on the power.

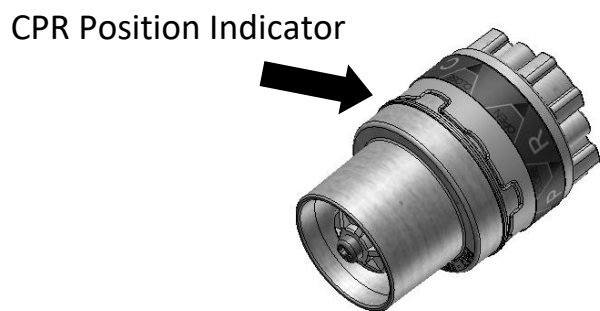

5. Position the Control Unit by its elastic hanger brackets over footboard of the bed. The elastic hanger brackets will self-adjust onto the footboard tightly.
6. Remove the Transport Cap of the hose connector and connect the hose connector to the Control Unit. Firmly push the hose connector into position and a "click" sound will secure the connection.

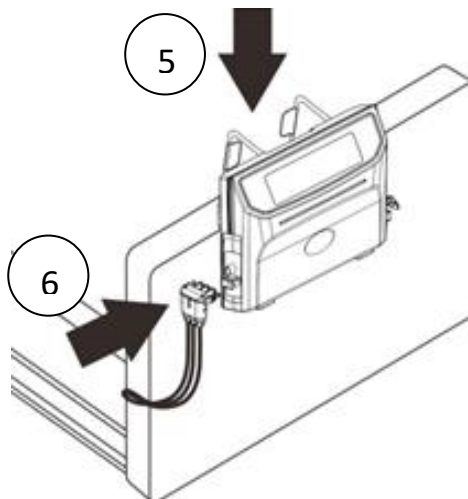

Follow the direction for connection.

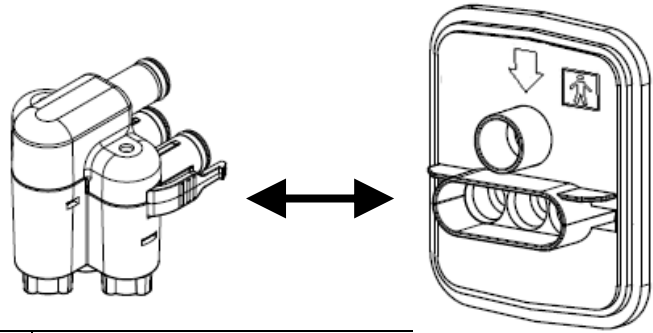

7. Connect the power cord to the Pump. The power switch should remain off.
8. Press the red power cord protector downward to secure the cord.
9. Plug the power cord into the electrical outlet.

- ⚠ NOTE: Check and ensure the Control Unit is suitable for the local power voltage.
- ⚠ CAUTION: The Control Unit can only be used with the mattress recommended by the manufacturer. Do not use the Control Unit for any other purpose.
- ⚠ WARNING: Do not place the Control Unit in any area where power cord can come off easily.

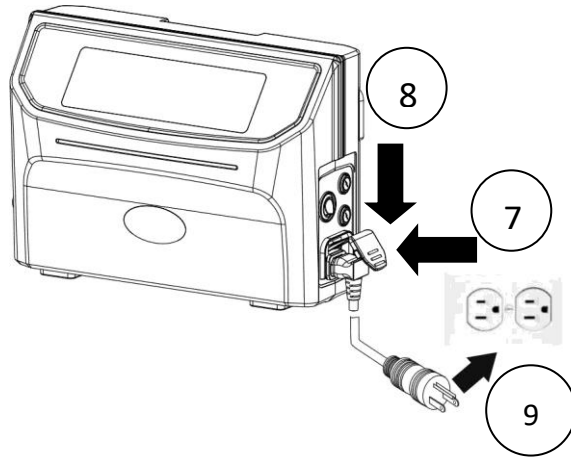

10. For patient transportation, press “Auto Firm” button and wait for 5 minutes for the mattress to be inflated. Disconnect the hose from the Control Unit and put on the hose connector Transport Cap to keep the mattress inflated.

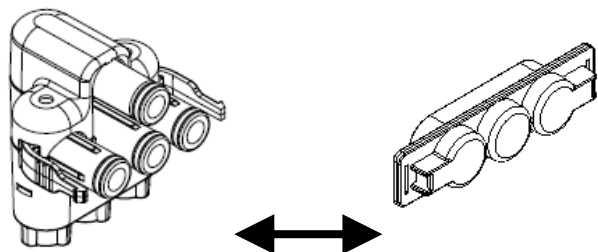

Bi-directional Transport Cap

5. PANEL DISPLAY AND OPERATION GUIDE

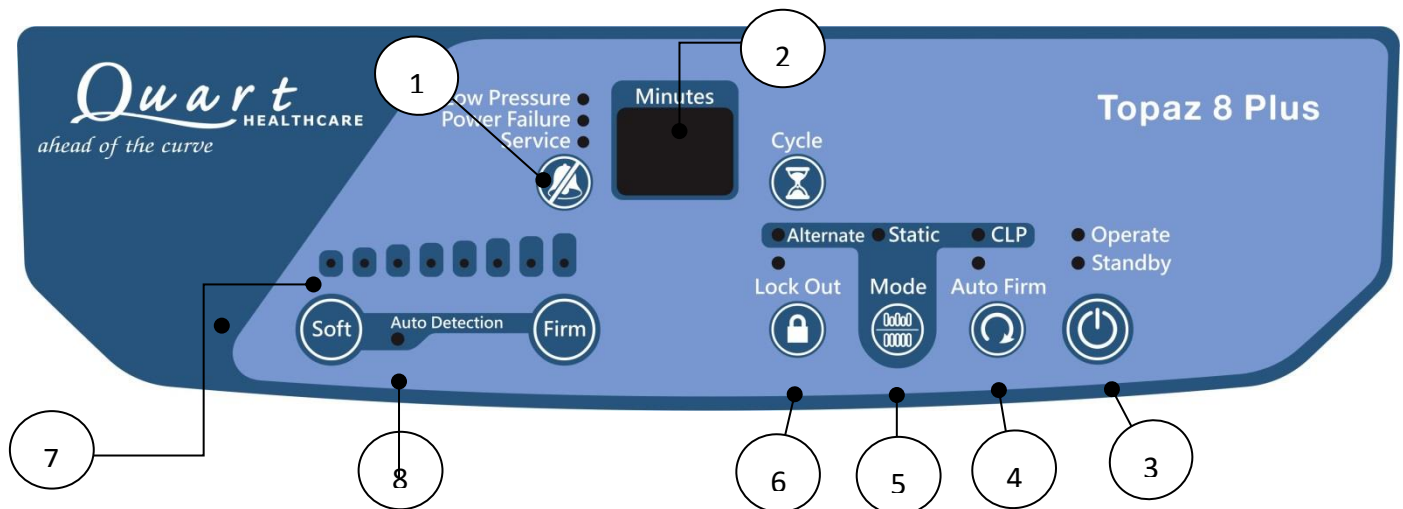

5.1 PANEL DISPLAY

- ① Alarm Mute and Alarm Indicator
 - Low Pressure Alarm Indicator
 - Power Failure Alarm Indicator
 - Service (Malfunction) Alarm Indicator
- ② Alternate Cycle Time or Warning Code Display
- ③ Operating or Standby
- ④ Auto-Firm
- ⑤ Function Mode Selection (Alternate/Static/Constant Low Pressure)
- ⑥ Panel Lock-out
- ⑦ Comfort Control
- ⑧ Auto Detection

5.1.1 Alarm Mute



Press the alarm mute button to temporarily suspend alarms. Should the situation not be resolved and fault conditions continue, the alarm will resume notifying the patient and caregiver.

5.1.2 Alternate Time Display



Alternate cycle time can be selected from 10-30 minutes by pressing the Cycle button.

5.1.3 Operate or Standby



Press this button to start operating or go into standby.



5.1.4 Auto-Firm

The Control Unit will go into the inflation mode (LED lights flashing) every time the operate mode is triggered. This insures the mattress is able to reach its maximum operating pressure. Once the max pressure level is reached, the Control Unit will automatically switch into the previous selected mode and comfort level. User can also use this function as full mattress inflation during patient sit-up or ingress/egress for better support.

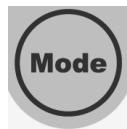

5.1.5 Function Mode Switch

- Alternate – the air cells of the mattress will be proportionally deflated to reduce the surface pressure. The alternating cycle will continue at the selected cycle time until another mode is selected.
- Static – the mattress maintains at the selected pressure. The Control Unit will automatically fall back to alternation mode after 20 minutes.
- Constant Low Pressure (CLP) – the mattress maintains at a reduced selected pressure in static mode.



5.1.6 Panel Lock-Out

Press the Lock-Out button to lock the panel. Should the panel remain untouched for 30 seconds; the Lock-Out feature will lock the panel to prevent anyone from accidentally changing settings without notice. To unlock, press the Lock-Out button for 3 seconds.



5.1.7 Comfort Level

Comfort level controls the air pressure output level. Press Firm button and the output pressure will increase and higher pressure output will support a higher weight; for decreasing air pressure, vice versa. Refer to **Table 1 Weight and Comfort Level Reference** for weight and comfort level suggestion.

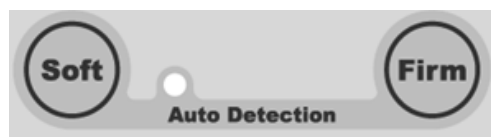



5.1.8 Auto Detection

Pressing both the Soft and Firm buttons together will activate Auto-Detection and Auto-Detection will automatically set the appropriate pressure output for the patient. When activated, the Auto-Detection light will flash to indicate the Control Unit is detecting the comfort level for the individual. Once the Control Unit has completed detecting, the Auto-Detection light will stop flashing and remain ON. The mattress pressure can be manually adjusted by pressing Soft or Firm button if the individual wishes to change the comfort level.

5.2 OPERATION GUIDE

5.2.1 General Operation:



 **NOTE:**  The power switch is located on the side of the Pump.

- Press  to turn on the unit, all LED indicators on the control panel will light up accompanied with a beep for 2 seconds (check for indicator failure if any), and the Standby indicator on the control panel will light up. If the Control Unit was previously shut off in operate mode then the Control Unit will enter operate mode directly.

P.S. To test the alarm battery, press  to turn off the power and the power failure alarm should be triggered. Refer to **5.2.3 Audiovisual Alarm** if the alarm is not triggered.



- Press the Operate button  and the system will begin to inflate and the "Auto-Firm" indicator will be flashing.
- The mattress should be fully inflated within 60 minutes, and automatically enter the previous operating mode, otherwise the low pressure alarm with warning code "LF" will be triggered.

 **Note:** Do not proceed to other settings before inflation is completed.

- After initial inflation is completed. Press Auto-Firm button  to transfer person onto the mattress. The mattress will turn into a static condition in around 5 minutes. Move the patient onto the mattress and press Auto-Firm button  again to cancel Auto-Firm mode and select the appropriate mode.
- According to the weight of the patient, adjust the pressure setting to the most suitable level without "bottoming-out". User can determine an appropriate pressure by adjusting the Comfort Level. Please consult with your physician for a proper setting.



Warning: the Control Unit should always be operating to prevent pressure wounds.

- In operate mode, press operate/standby button  for the system to enter standby mode. The system should be in standby mode before shut down. Switch the power switch  to off and the warning code “S.d.” will appear on the display to shut off the system.





Note: Power failure alarm will be triggered if the power is switched off in operating mode (refer to **5.2.3 Audiovisual Alarm**). Press power switch  to restart the system, or press Alarm Mute  to turn off the system (refer **5.2.4 Alarm Mute**).

Table 1 Weight and Comfort Level Reference

Comfort Control (Indicators)	Patient Weight									
	44	88	132	176	220	264	308	352		(lb)
	20	40	60	80	100	120	140	160	180	(kg)

5.2.2 CPR

- When CPR needs to be performed, quickly rotate the CPR valve to “OPEN” position, at the same time, disconnect the hose connector from the Control Unit to speed up the air release.

5.2.3 Audiovisual Alarm

- Power Failure – When electrical shortages occur or power cord is unplugged without turning off the Control Unit or  is pressed (intentionally or unintentionally), the “Power Failure” indicator will light up along with buzzer and will last 20 minutes.



NOTE: When the Control Unit has not been used for more than 3 months, the Control Unit may need 6 hours or more of operating time for the alarms to function properly.

- Low Pressure – When an abnormal low pressure occurs in the body section, the "Low Pressure" indicator will flash and beep. Should the situation not resolve and fault conditions continue, the alarm will resume.
- Service (Malfunction) – When fault conditions occur, the "Service" indicator will light up along with buzzer sound.









Note: Refer to **Table 2 for Warning Code Reference Table** if error code appears on the display or refer to **10. TROUBLESHOOTING**.

5.2.4 Alarm Mute

- When alarms are triggered, both LED light and buzzer will turn on to warn the patient and caregiver. By pressing the button, it will temporarily mute the buzzer so the caregiver may check for possible causes. Should the situation not be resolved and fault conditions continue, the alarm will resume. Refer to **10. TROUBLESHOOTING** for diagnosis.
- During “power failure”, pressing “alarm mute” will cease all buzzers and indicators and turn off the system.
- During “low pressure alarm” if the pressure resumes back to normal, then the low pressure alarm will stop.
- When more than one alarm is triggered, the alarm will be performed according to priority level. Refer to **Table 2 Warning Code Reference Table** for priority level.

Table 2 Warning Code Reference

PRIORITY HIGH ↓ LOW	WARNING CODE	INDICATOR LED	AUDIBLE OUTPUT MODE	CONDITION OF OUTPUT	WARNING DESCRIPTION	REMARKS
0	N/A	N/A	ONCE	Not in System Shutdown	Key Tone	Key Tone from Functional Button
1		Power Failure	ONCE	POWER-OFF	System Shutdown	Shutdown
2		ALL LED	ONCE	OPERATE OR STANDBY	Power-On	All Indicators Light On
3	N/A	N/A	ONCE	OPERATE OR STANDBY	State/Mode Switching	No Display
4		Auto Firm	ONCE	OPERATE	Mattress Inflation Completion	Inflation Ended
5		Auto Firm	ONCE	OPERATE	Auto-Firm Completion	Auto-Firm Ended
6		Static	ONCE	OPERATE	Static Completion	Static Ended
7	N/A	Power Failure	REPEAT (Cycle 4 sec.)	POWER-OFF	Power Failure Alarm	No Display
8		Low Pressure	REPEAT (Cycle 4 sec.)	OPERATE OR STANDBY	Power-On Inflation Failure Alarm	Inflate Failure
9		Low Pressure	REPEAT	OPERATE OR	Auto-Firm Failure Alarm	Auto-Firm Failure

			(Cycle 4 sec.)	STANDBY		
10		Low Pressure	REPEAT (Cycle 4 sec.)	OPERATE OR STANDBY	Low Pressure Overtime Alarm	Low Pressure
11		Service	REPEAT (Cycle 4.5 sec.)	OPERATE OR STANDBY	High Pressure Overtime Alarm	High Pressure
12		Service	REPEAT (Cycle 4.5 sec.)	OPERATE OR STANDBY	High Ambient Temperature Alarm	High Temperature
13		Service	REPEAT (Cycle 4.5 sec.)	OPERATE OR STANDBY	Air Valve 1 Positioning Failure Alarm	Air Valve 1 failure
14		Service	REPEAT (Cycle 15 sec.)	OPERATE OR STANDBY	Battery Low Alarm	Battery may need recharging or may need to be replaced
15		NONE	NONE	FACTORY CALIBRATION MODE	Calibration Not Completed	Calibration Unfinished
16		NONE	NONE	FACTORY CALIBRATION MODE	Calibration Completed	Calibration Completed

6. CLEANING

Wipe the Control Unit with a damp cloth pre-soaked with a mild detergent, and keep the Control Unit away from dust. If other detergent is used, choose one that will have no chemical effects on the surface of the plastics case of the Control Unit.



CAUTION: Do not immerse or soak the Control Unit.

Clean the mattress cover by using single use wipes with a solution of neutral detergent and hand hot water. Rinse thoroughly with clean water and damp dry the mattress using single use wipes.

Disinfecting the cover

If the cover is heavily soiled or has been exposed to bodily fluids such as blood, it will require a more thorough cleaning procedure.

Use single use wipes with a 0.1% chlorine solution (1,000ppm) and cold water to wipe the cover. Rinse thoroughly with clean water and damp dry the mattress using single use wipes. Ensure the cover is completely dried before placing on the mattress.

Frequent or prolonged exposure to higher concentration disinfectant solutions may prematurely age the fabric cover of mattresses. Cover surfaces should be protected during use and rinsed and dried thoroughly after disinfectant.

Laundering

- Before laundering, mattress cover should be completely removed.
- Mattress covers can be laundered as following:
 - Prewash 60°C +15 minutes
 - Main wash 60°C+15 minutes
- This should be followed by a cold rinse and extraction.

Drying

Mattress covers should be hung from a line or bar and drip dried in a clean indoor environment. Covers must be completely dried before returning to the mattress.

Mattress covers can be tumble dried on a low heat setting for 90 minutes. Drying temperature must not exceed 40°C. Exceeding the temperature can cause significant damage to the mattress cover.

 *CAUTION: Do not use phenolic-based product for cleaning.*

 *CAUTION: After cleaning, dry the mattress without direct exposure of sunlight.*

7. STORAGE

- To quickly vacuum air out from mattress for storage, rotate the CPR valve to OPEN position and disconnect the hose connector to release the air.
- Lay the mattress out flat and upsides down.
- Roll from the head end towards the foot end.
- Packing strap can then be stretched around the rolled mattress to prevent unrolling.
- The power cord could be wrapped around the Control Unit bumper or disconnected for storage.

8. MAINTENANCE

General

- Check main power cord and plug for any abrasions or excessive wear.
- Check mattress cover for signs of wear or damage. Ensure mattress cover and tubes are stubbed together correctly.
- Check the air hoses for any kink or break. For replacement, please contact your local dealer.

Fuse replacement

- Disconnect the plug from main power when a blown fuse is suspected.
- Remove the cover of the fuse holder by means of a small screwdriver.
 - Insert a new fuse of the correct rating, and replace the cover of the fuse holder. The fuse rating should comply with the requested specification.

Air Filter Replacement

After checking **10. TROUBLESHOOTING**, if the air filter needs to be replaced:

- Replace the air filter located at the back of the Pump.
- The filter is reusable and can be washed gently with a mild detergent and water. Dry the filter before use.
- Check and replace air filter regularly if environment is dirty.

9. DISPOSAL OF AIR MATTRESS

When the air mattress is no longer useable, the mattress and the Control Unit may be discarded.

10. TROUBLESHOOTING

PROBLEM	SOLUTION
The mattress is not able to connect to the Control Unit	<ul style="list-style-type: none">● Check if the mattress model (model no. located inside the cover by the foot end) xxAAAxix matches with the Control Unit model xxBBB-xxx. The AAA should be the same as BBB. If not, please contact your dealer.● Check if the Transport Cap is removed and make sure the connector is not broken.
The Control Unit is not working	<ul style="list-style-type: none">● Check if the plug is connected to the mains supply.● Check if the power switch is switched to ON position (press ).● Check if there is a blown fuse.
Power failure alarm failed	<ul style="list-style-type: none">● If the Control Unit is in operation but failed to trigger the power failure alarm during power off. Charge the Control Unit for 6 hours or more of operating time and if the power failure still does not work, contact your dealer.
The low pressure light is constantly flashing and the alarm is sounding	<ul style="list-style-type: none">● Check if the CPR is in the CLOSE position● Check if the connection between the air tubes to Control Unit is tightly secured.● Check if all coupling connections between the air cells and side rail are secured.● If the main power supply is normal but there is no sound from the Control Unit, please remove the connector from the Control Unit to check if there is air coming out. If not, please turn off the Control Unit and contact your dealer.

	<ul style="list-style-type: none"> ● If all of above steps have been checked. Press “Alarm Mute” for system to be verified again.
The Control Unit is on but the mattress is not alternating	<ul style="list-style-type: none"> ● Ensure the mattress has completely inflated. ● Check the control panel, the indicator light for “Alternate” should be on, if not, switch it to “Alternate.” ● Check if “Service” alarm indicator is on with buzzer, if yes, contact the dealer.
Service (Malfunction) Alarm is on	<ul style="list-style-type: none"> ● Press “alarm mute” for system to be verified again. If the alarm is still on, please contact dealer or agent.
The Control Unit is noisy	<ul style="list-style-type: none"> ● Make sure the Control Unit is resting against a solid surface. ● If the noise is getting louder, contact your dealer for further investigation.
Patient is bottoming out (without alarm triggered)	<ul style="list-style-type: none"> ● Pressure settings might be inadequate for the patient, adjust comfort level to FIRM (refer to Table 1 Weight and Comfort Level Reference Table) and wait for a few minutes for better comfort. ● Follow the procedures “The low pressure light is constantly flashing and the alarm has sounded” for inspection.

If the above information does not solve the problem, please contact your local dealer or agent for further support.

11. TECHNICAL DATA

11.1 Product Specification

CONTROL UNIT		AIR MATTRESS	
DIMENSION(cm)	33 (W) x 24 (D) x13 (H)	DIMENSION(cm)	200 (L) x 90 (W) x 20 (H)
WEIGHT(kg)	3.5	WEIGHT(kg)	9
CYCLE TIME	10/15/20/25/30minutes	CELL MATERIAL	TPU
STATIC TIME	20 minutes	NO. OF AIR CELL	18 Cells
AUTO FIRM TIME	20 minutes	COVER MATERIAL	Two way stretch polyester
CONTROL UNIT OUTPUT FLOW RANGE (Liter)	> 8L (120V) Note: The flow rate may be varied because of the fluctuation of input voltage	BOTTOM MATERIAL	Polyester-PU
CONTROL UNIT OUTPUT PRESSURE RANGE (mmHg)	15 to 50 (±5)	MAX WEIGHT	350 lbs
POWER	AC120 V 60Hz		
CURRENT	0.25A _{MAX} (@132V~)		
FUSE RATING	T1A 250VAC		
FREQUENCY	60 Hz (120V)		
CLASSIFICATION	Class II		
	Type BF 		
WARRANTY	1 year	WARRANTY	1 year

ENVIRONMENTAL CONDITIONS

OPERATION ENVIRONMENT	5°C ~40°C 15%RH ~ 93%RH(no condensation)
STORAGE ENVIRONMENT	-25°C~70°C ≦ 93%RH(no condensation)
ENVIRONMENT PRESSURE	70 kPa-101.3kPa
ENVIRONMENT HORIZONTAL LEVEL	≦3000m
WATER AND DUST PROTECTION CLASSIFICATION	IP21

EMC INFORMATION (120V)

Guidance and manufacturer's declaration-electromagnetic emissions		
<p>The <u>device(s)</u> is intended for use in the electromagnetic environment specified below. The customer or the user of the <u>device(s)</u> should assure that it is used in such environment.</p>		
Emission test	Compliance	Electromagnetic environment-guidance
RF emissions CISPR 11	Group 1	The <u>device(s)</u> uses RF energy only for its internal function. Therefore, its RF emissions are very low and are not likely to cause any interference in nearby electronic equipment.
RF emissions CISPR 11	Class B	The <u>device(s)</u> is suitable for use in all establishments, including domestic establishments and those directly connected to the public low-voltage power supply network that supplies buildings used for domestic purposes.
Harmonic emissions IEC 61000-3-2	Class A	
Voltage fluctuations /flicker emissions IEC 61000-3-3	Compliance	

Guidance and manufacturer's declaration-electromagnetic immunity

The device(s) is intended for use in the electromagnetic environment specified below.

The customer or the user of the device(s) should assure that it is used in such an environment.

Immunity test	IEC 60601 test level	Compliance level	Electromagnetic environment-guidance
Electrostatic discharge(ESD) IEC 61000-4-2	± 6 kV contact ± 8 kV air	± 6 kV contact ± 8 kV air	Floors should be wood, concrete or ceramic tile. If floors are covered with synthetic material, the relative humidity should be at least 30%
Electrical fast transient/burst IEC 61000-4-4	± 2kV for power supply lines ± 1kV for input/output lines	± 2kV for power supply lines Not applicable	Mains power quality should be that of a typical commercial or hospital environment.
Surge IEC 61000-4-5	± 1kV line(s) to line(s) ± 2kV line(s) to earth	± 1kV differential mode Not applicable	Mains power quality should be that of a typical commercial or hospital environment.
Voltage Dips, short interruptions and voltage variations on power supply input lines IEC 61000-4-11	<5% UT(>95% dip in UT) for 0,5 cycle 40% UT(60% dip in UT) for 5 cycles 70% UT(30% dip in UT) for 25 cycles <5% UT(>95% dip in UT) for 5 s	<5% UT(>95% dip in UT) for 0,5 cycle 40% UT(60% dip in UT) for 5 cycles 70% UT(30% dip in UT) for 25 cycles <5% UT(>95% dip in UT) for 5 s	Mains power quality should be that of a typical commercial or hospital environment. If the user of the <u>device(s)</u> requires continued operation during power mains interruptions, it is recommended that the <u>device(s)</u> be powered from an uninterruptible power supply or a battery.
Power frequency(50/60 Hz) magnetic field IEC 61000-4-8	3 A/m	3 A/m	The <u>device(s)</u> power frequency magnetic fields should be at levels characteristic of a typical location in a typical commercial or hospital environment.
NOTE UT is the a.c. mains voltage prior to application of the test level.			

Guidance and manufacturer's declaration-electromagnetic immunity			
The <u>device(s)</u> is intended for use in the electromagnetic environment specified below.			
The customer or the user of the <u>device(s)</u> should assure that is used in such and environment.			
Immunity test	IEC 60601 test level	Compliance level	Electromagnetic environment-guidance
Conducted RF IEC 61000-4-6	3 Vrms 150 KHz to 80 MHz	3 Vrms	<p>Portable and mobile RF communications equipment should be used no closer to any part of the <u>device(s)</u> including cables, than the recommended separation distance calculated from the equation applicable to the frequency of the transmitter.</p> <p>Recommended separation distance:</p> $d = 1,2 \sqrt{P}$ $d = 1,2 \sqrt{P} \quad 80\text{MHz to } 800 \text{ MHz}$ $d = 2,3 \sqrt{P} \quad 800\text{MHz to } 2,5 \text{ GHz}$ <p>Where P is the maximum output power rating of the transmitter in watts (W) according to the transmitter manufacturer and d is the recommended separation distance in metres (m).</p> <p>Field strengths from fixed RF transmitters, as determined by an electromagnetic site survey,^a should be less than the compliance level in each frequency range.^b</p> <p>Interference may occur in the vicinity of equipment marked with the following symbol:</p> 
NOTE1 At 80 MHz and 800 MHz, the higher frequency range applies.			
NOTE2 These guidelines may not apply in all situations. Electromagnetic propagation is affected by absorption and reflection from structures, objects and people.			
<p>a Field strengths from fixed transmitters, such as base stations for radio (cellular/cordless) telephones and land mobile radios, amateur radio, AM and FM radio broadcast and TV broadcast cannot be predicted theoretically with accuracy. To assess the electromagnetic environment due to fixed RF transmitters, an electromagnetic site survey should be considered. If the measured field strength in the location in which the <u>device(s)</u> is used exceeds the applicable RF compliance level above, the <u>device(s)</u> should be observed to verify normal operation. If abnormal performance is observed, additional measures may be necessary, such as re-orienting or relocating the <u>device(s)</u>.</p>			
<p>b Over the frequency range 150 kHz to 80 MHz, field strengths should be less than 3 V/m.</p>			

**Recommended separation distance between
portable and mobile RF communications equipment and the device(s)**

The device(s) is intended for use in an electromagnetic environment in which radiated RF disturbances are controlled. The customer or the user of the device(s) can help prevent electromagnetic interference by maintaining a minimum distance between portable and mobile RF communications equipment (transmitters) and the device(s) as recommended below, according to the maximum output power of the communications equipment.

Rated maximum output power of transmitter W	Separation distance according to frequency of transmitter m		
	150 kHz to 80 MHz $d = 1,2\sqrt{P}$	80 MHz to 800 MHz $d = 1,2\sqrt{P}$	800 MHz to 2,5 GHz $d = 2,3\sqrt{P}$
0,01	0,12	0,12	0,23
0,1	0,38	0,38	0,73
1	1,2	1,2	2,3
10	3,8	3,8	7,3
100	12	12	23

For transmitters rated at a maximum output power not listed above, the recommended separation distance d in metres (m) can be estimated using the equation applicable to the frequency of the transmitter, where p is the maximum output power rating of the transmitter in watts (W) according to the transmitter manufacturer.

NOTE1 At 80 MHz and 800 MHz, the separation distance for the higher frequency range applies.

NOTE2 These guidelines may not apply in all situations. Electromagnetic propagation is affected by absorption and reflection from structures, objects and people.