

Canadian Suggested Retail Price List

January 2014

Phone: 1-800-336-7684

Fax: 704-882-0751

www.snugseat.com

PO Box 1739 Matthews, NC 28106

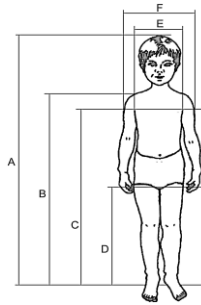

A (Total height) _____
 C (Chest height) _____
 D (Buttock height) _____
 E (Chest width) _____
 Age _____
 Weight _____

Features, included in standard price

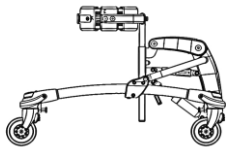

Four sizes
 4 wheels, solid
 Drag wheel function
 Reverse brake on/off

Chest support, height/width adjustable
 Angle adjustable center spar
 Height adjustable center spar
 Directional stabilizer

Measurements

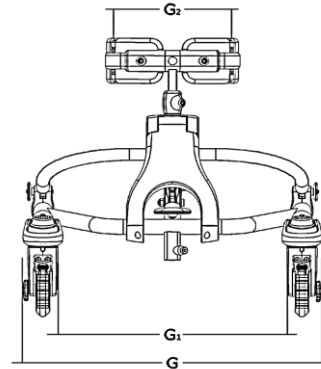
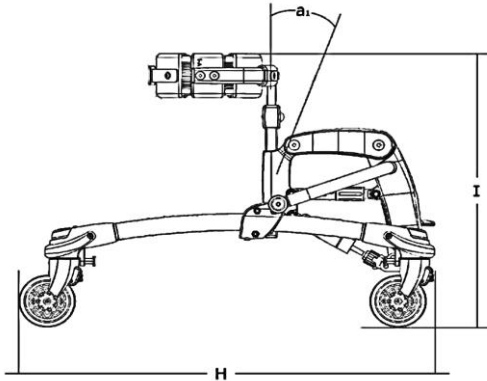







| | Size 1 | Size 2 | Size 3 | Size 4 |
|--------------------------------------|----------|----------|----------|----------|
| Width, total (G) | 20¼" | 24½" | 25½" | 27½" |
| Width, inside frame (G1) | 14¾" | 17½" | 19½" | 22" |
| Width, inside chest support (G2) | 6½-9" | 9-10½" | 11¾-15½" | 11¾-15½" |
| Length, total (H) | 29¾" | 35" | 39" | 43" |
| Height, total (I) - 4" casters | 25¼" | 27¼" | N/A | N/A |
| Height, total (I) - 8" casters | 29¼" | 31¼" | 41" | 50¾" |
| Seat height above floor | 6½-13½" | 12¾-19½" | 17½-26½" | 24-32¾" |
| Width between handles | 5½-13½" | 5½-13½" | 5½-23½" | 5½-23½" |
| Height from floor to handles | 14½-22½" | 20-27¾" | 25½-35" | 31½-48¾" |
| Angle range of center bar (a1) | 30° | 30° | 0-25° | 0-25° |
| Turning radius | 17½" | 21½" | 21½" | 24¼" |
| User height, floor to axilla | 14¾-25¼" | 23½-31¼" | 27½-41½" | 34-50¾" |
| Weight, standard without accessories | 22 lb | 31 lb | 40 lb | 42 lb |
| Max. load / user weight | 66 lb | 88 lb | 132 lb | 176 lb |
| Approximate User Age | 1 to 4 | 3 to 7 | 5 to 12 | 9 to 16 |

Account No. _____ Drop Ship: _____
 Date: _____ Name _____
 P.O. Number: _____ Address _____
 Buyer: _____ City _____
 Marked For: _____ State _____ Zip _____
 E Mail: _____ Tel. _____ Fax _____





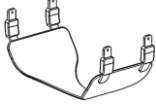

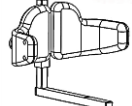
Phone: 1-800-336-7684 Fax: 704-882-0751 www.snugseat.com PO Box 1739 Matthews, NC 28106

| | Description | Size | Part No. | CDN - Price | |
|---|-------------------------------|--------|----------|-------------|--------------------------|
|  | Mustang - Yellow - 4" Casters | size 1 | 869011 | 2,395 | <input type="checkbox"/> |
| | Mustang - Yellow - 8" Casters | size 1 | 869015 | 2,450 | <input type="checkbox"/> |
| | Mustang - Blue - 4" Casters | size 2 | 869025 | 2,485 | <input type="checkbox"/> |
| | Mustang - Blue - 8" Casters | size 2 | 869021 | 2,485 | <input type="checkbox"/> |
| | Mustang - Red | size 3 | 869031 | 3,510 | <input type="checkbox"/> |
| | Mustang - Blue | size 4 | 869041 | 4,150 | <input type="checkbox"/> |

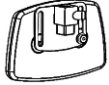
Accessories

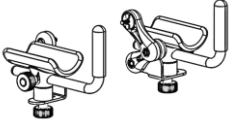
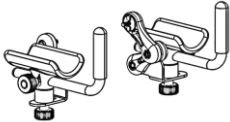
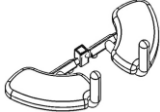
| | | | | | |
|---|--|------------|------------|-----|--------------------------|
|  | Chest Support, 18½" to 25¼" | small | 869810 | N/C | <input type="checkbox"/> |
| | Chest Support, 26¼" to 30¾" | medium | 869820 | N/C | <input type="checkbox"/> |
| | Chest Support, 34¼" to 45" | large | 869830 | N/C | <input type="checkbox"/> |
| | Measurements = inner circumference | | | | |
|  | Pelvis Support, 18½" to 25¼" | small | 869610 | 595 | <input type="checkbox"/> |
| | Pelvis Support, 26¼" to 30¾" | medium | 869620 | 625 | <input type="checkbox"/> |
| | Pelvis Support, 34¼" to 45" | large | 869630 | 650 | <input type="checkbox"/> |
| | Measurements = inner circumference | | | | |
|  | Extra pad for chest support | One size | 869225 | 75 | <input type="checkbox"/> |
|  | Cover for chest support | large | 869830-360 | 210 | <input type="checkbox"/> |
|  | Sling seat - use with small chest support | size 1 | 869570 | 210 | <input type="checkbox"/> |
| | Sling seat - use w/ medium chest support | size 2 | 869571 | 210 | <input type="checkbox"/> |
|  | Mustang seat | size 1 + 2 | 869110 | 310 | <input type="checkbox"/> |
| | Mustang seat | size 3 + 4 | 869120 | 330 | <input type="checkbox"/> |
|  | <i>Hip and Sacrum supports require 869110 - Mustang seat</i> | | | | |
| | Hip supports with head support bracket | size 1 + 2 | 869221 | 475 | <input type="checkbox"/> |
| | Hip supports with head support bracket | size 3 + 4 | 869231 | 500 | <input type="checkbox"/> |

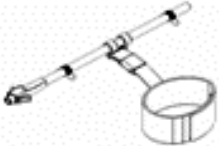
Phone: 1-800-336-7684 Fax: 704-882-0751 www.snugseat.com PO Box 1739 Matthews, NC 28106

| | Description | Size | Part No. | Price | |
|---|--|------------|----------|-------|--------------------------|
|  | Sacrum support with head support bracket | small | 869250 | 210 | <input type="checkbox"/> |
| | Sacrum support with head support bracket | large | 869255 | 300 | <input type="checkbox"/> |
|  | Abdominal support | One size | 869260 | 125 | <input type="checkbox"/> |
|  | Arm support for anterior use | small | 869360 | 265 | <input type="checkbox"/> |
| | Arm support for anterior use | large | 869365 | 265 | <input type="checkbox"/> |
|  | Arm prompts for anterior use | small | 869310 | 455 | <input type="checkbox"/> |
| | Arm prompts for anterior use | medium | 869320 | 455 | <input type="checkbox"/> |
| | Arm prompts for anterior use | large | 869325 | 525 | <input type="checkbox"/> |
|  | Arm prompts for posterior use | small | 869330 | 460 | <input type="checkbox"/> |
| | Arm prompts for posterior use | medium | 869340 | 460 | <input type="checkbox"/> |
| | Arm prompts for posterior use | large | 869345 | 525 | <input type="checkbox"/> |
|  | Arm rests anterior incl. handles | small | 869350 | 490 | <input type="checkbox"/> |
| | Arm rests anterior incl. handles | large | 869355 | 645 | <input type="checkbox"/> |
|  | Leg separator | size 1 | 869410 | 370 | <input type="checkbox"/> |
| | Leg separator | size 2 | 869420 | 370 | <input type="checkbox"/> |
| | Leg separator | size 3 | 869430 | 485 | <input type="checkbox"/> |
| | Leg separator | size 4 | 869440 | 485 | <input type="checkbox"/> |
|  | Attendant guide bar | size 1 + 2 | 869510 | 280 | <input type="checkbox"/> |
|  | Ankle Prompt System | size 1 | 869450 | 240 | <input type="checkbox"/> |
| | Ankle Prompt System | size 2 | 869455 | 240 | <input type="checkbox"/> |
| | Ankle Prompt System | size 3 | 869460 | 255 | <input type="checkbox"/> |
| | Ankle Prompt System | size 4 | 869465 | 255 | <input type="checkbox"/> |
|  | Leg pad | one size | 869470 | 180 | <input type="checkbox"/> |
|  | Storage pouch | size 1 + 2 | 869560 | 125 | <input type="checkbox"/> |
| | Storage bag | size 3 + 4 | 869565 | 255 | <input type="checkbox"/> |

| Description | Size | Part No. | Price | |
|--|---|----------|--------------------------|--------------------------|
| Headrests - Requires Hip or Sacrum Supports & Connecting Rod | | | | |
| Pad Style | | | | |
|  | Head support no. 1, Black Polyurethane (cover optional) | 6171550 | 290 | <input type="checkbox"/> |
| | Head support no. 2, Black Polyurethane (cover optional) | 6172550 | 290 | <input type="checkbox"/> |
| | Head support no. 3, Black Polyurethane (cover optional) | 6173550 | 290 | <input type="checkbox"/> |
| | Head support no. 4, Black Polyurethane (cover optional) | 6174550 | 290 | <input type="checkbox"/> |
| | Anatomic head support*, Small - A = 3", B = 8" | 5099001 | 325 | <input type="checkbox"/> |
| | Anatomic head support*, Medium - A = 3", B = 10¼" | 5099002 | 325 | <input type="checkbox"/> |
| | Anatomic head support*, Large - A = 4¼", B = 13" | 5099003 | 325 | <input type="checkbox"/> |
| <i>*Includes black Ducutex cover</i> | | | | |
| Headband System (For Anatomic Head Support only) | 99500 | 290 | <input type="checkbox"/> | |
| Extra headband strap (For Anatomic Head Support only) | 99400-5 | 75 | <input type="checkbox"/> | |
| Swing-away Mounting Bracket - Height, Depth, Angle & Lateral Adjustable | | | | |
| Turtle bar system, short | 98619-25 | 310 | <input type="checkbox"/> | |
| Turtle bar system, long | 98619-26 | 310 | <input type="checkbox"/> | |
| Connecting Rod - Required to connect headrest to Hip or Sacrum supports | 869226 | 85 | <input type="checkbox"/> | |

NOTES